



WITT

Innovative and Customized Solutions for Your Space

Blending Functionality with Design



The Art of Customization

Transforming spaces with bespoke design solutions.

Elevate your design vision with Witt Custom waste receptacles – where functionality meets artistry.

Our customizable solutions empower architects and designers to seamlessly integrate waste management into their aesthetic narrative, transforming spaces into curated expressions of sophistication. Experience the fusion of form and function with Witt Custom, where every detail is a testament to your unique design sensibilities.



Custom Logo Receptacles

Amplify your brand identity with Witt Custom. Our tailor-made trash receptacles, recycling bins, and outdoor benches provide architects and designers the perfect canvas to showcase brand expression. Ideal for stadiums, universities, corporate headquarters, and more – make a lasting impact with Witt's custom logo products

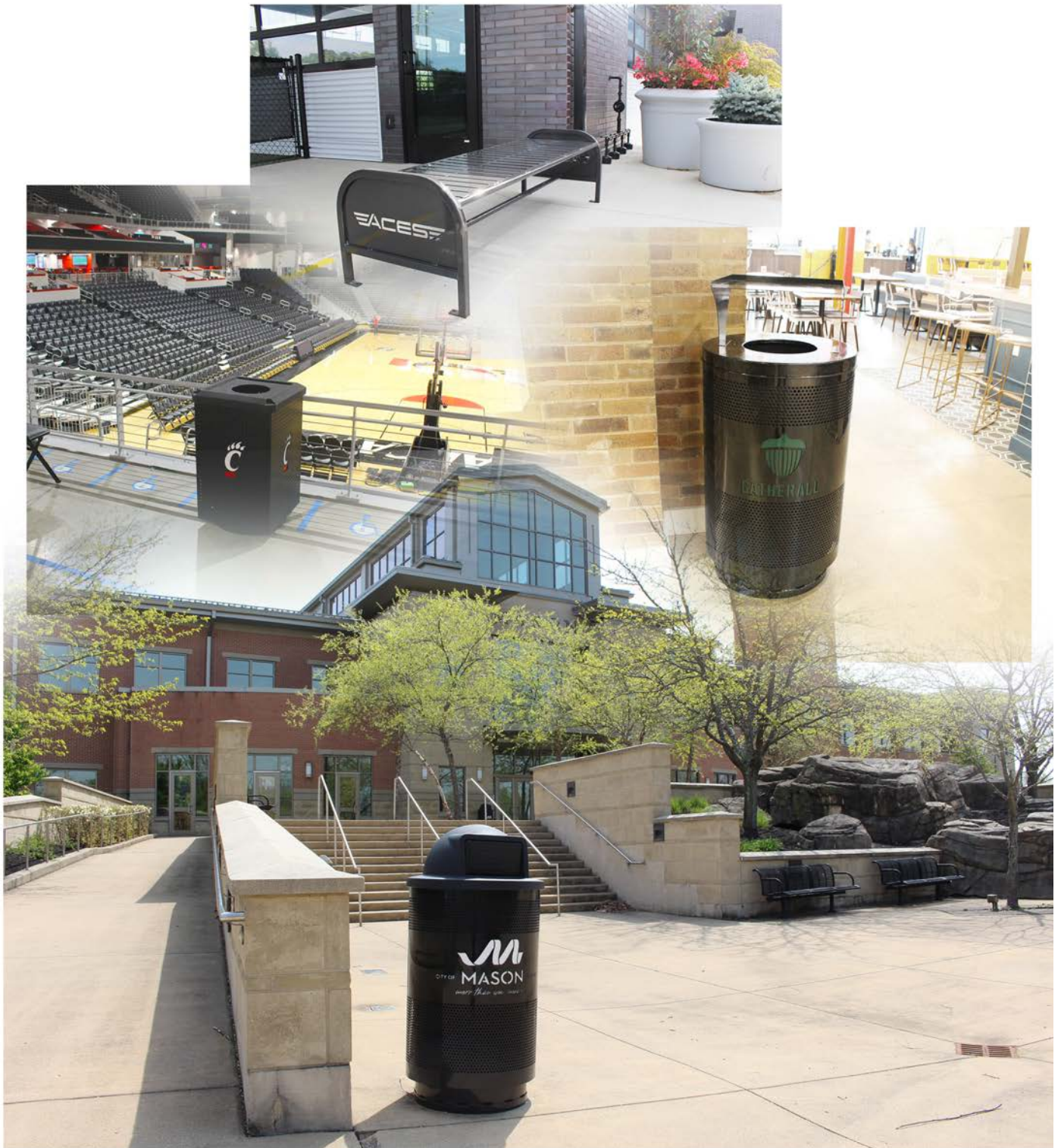

Lasered Designs

Explore Witt Industries' versatile product line for design-centric solutions. From indoor waste receptacles to outdoor benches, our range complements professional, industrial, and commercial spaces. Addressing the demand for green alternatives, our high-quality recycling receptacles, crafted from recycled materials, showcase our commitment to sustainable design.

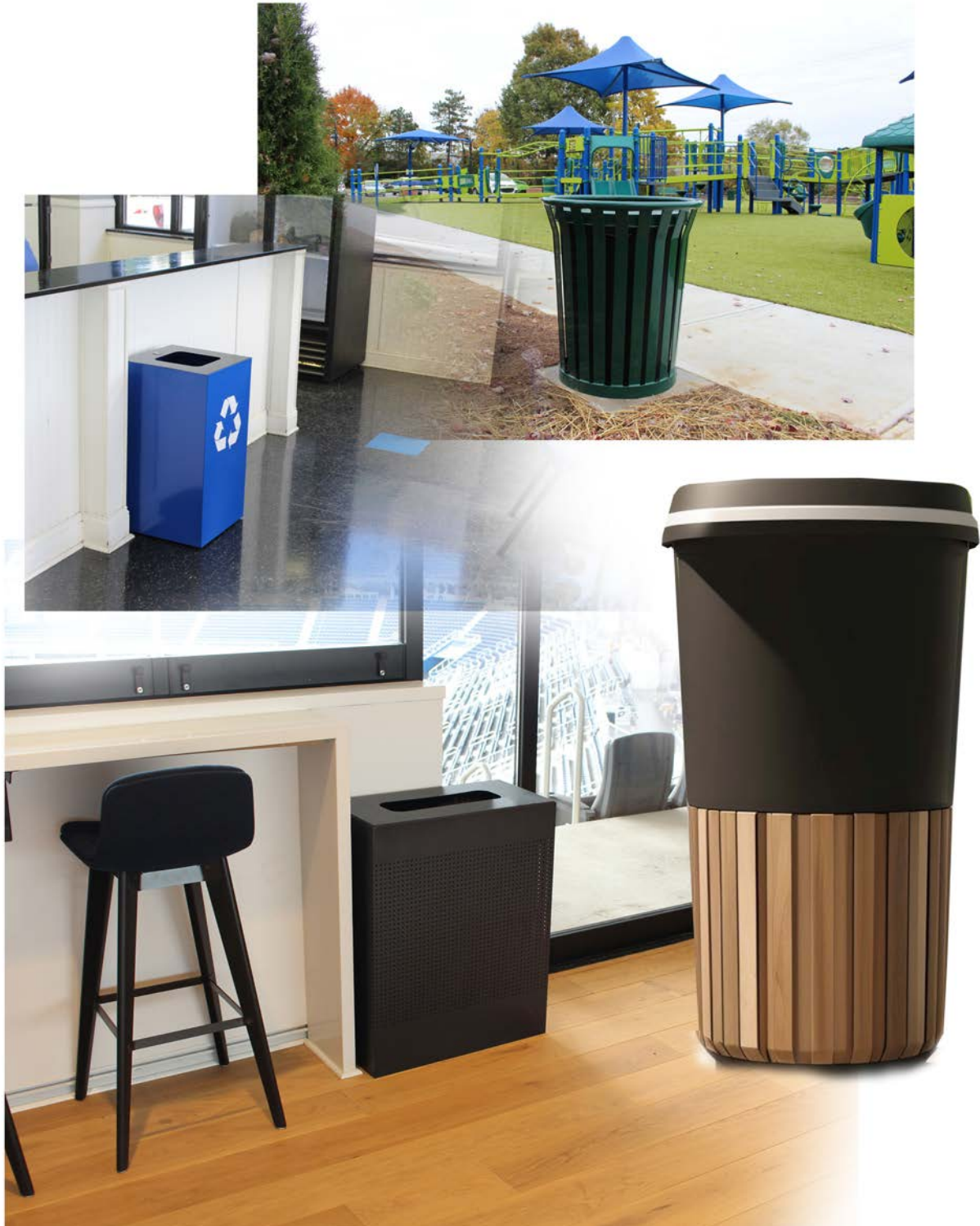

Customer Praise and Recommendations

“Our custom Witt receptacles are durable and fit the needs of our players, staff, and fans alike, all while looking great and furthering the FC Cincinnati brand.”

– FC Cincinnati, Professional Soccer Team



“The branded receptacles add to the sophistication of our distillery and our customer’s experience.”

– Dan Callaway, Vice President, Hospitality & Product Development, Bardstown Bourbon Company



“The Witt team was exceedingly easy to work with, and their branded receptacles met our program standards for durability and economy. The aesthetics of the final trash receptacles blend perfectly with the Idaho Central Credit Union Arena décor.”

– Guy Esser, Project Architect, University of Idaho



SC55P-02 Specifications

55 Gallon Custom Logo Waste Receptacle



WITT

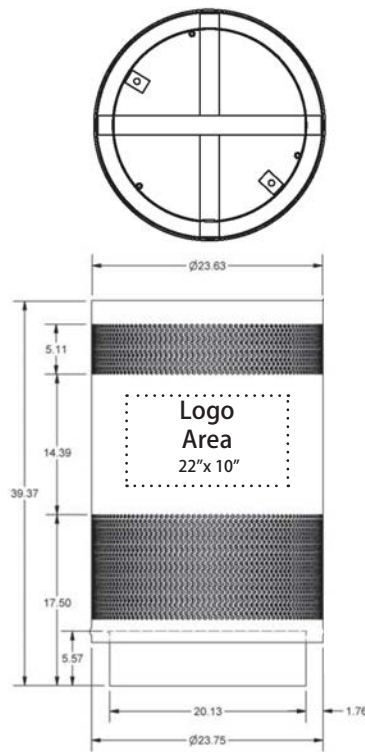

Dimensions represent can only lid accounted for separately

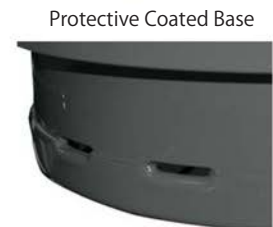

Product Features:

- Custom logo capability to convey branding
- 14 GA. Galvaneal metal body with 12 GA. Galvaneal metal base
- Perforation Pattern: 3/8"
- Unit comes standard with Leveling Feet, Anchoring Feet, Anchor Kit and Lid Attachment Kit
- TGIC Polyester Powder Coat outdoor finish
- Custom colors available to match organizational branding
- 3 Tops to choose from: Flat Top, Hood Top or Dome Top

BOTTOM VIEW

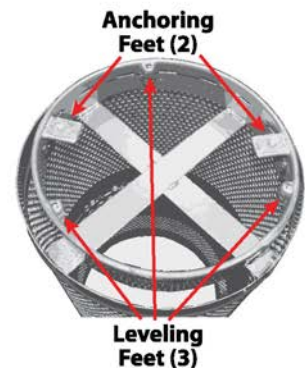

Item Number	Capacity	Dimensions	Weight
SC55P-02	55 gallons	23 1/2" dia x 40" high	86 lbs

SC35P-02 Specifications

35 Gallon Custom Logo Waste Receptacle



WITT

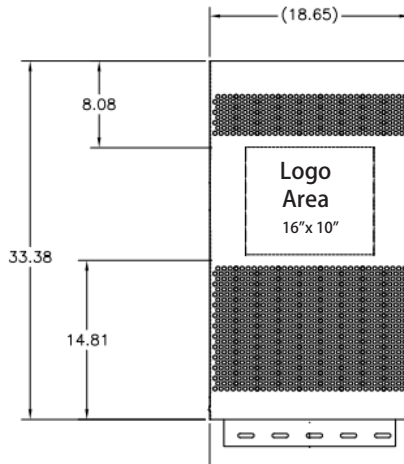
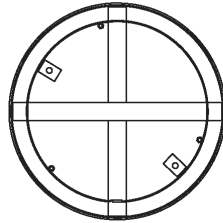

Dimensions represent can only lid accounted for separately

Product Features:

- Custom logo capability to convey branding
- 14 GA. Galvaneal metal body with 12 GA. Galvaneal metal base
- Perforation Pattern: 3/8"
- Unit comes standard with Leveling Feet, Anchoring Feet, Anchor Kit and Lid Attachment Kit
- TGIC Polyester Powder Coat outdoor finish
- Custom colors available to match organizational branding
- 3 Tops to choose from: Flat Top, Hood Top or Dome Top



BOTTOM VIEW

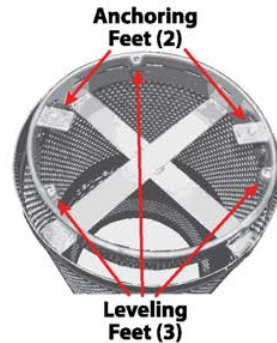

Item Number	Capacity	Dimensions	Weight
SC35P-02	35 gallons	18.5" dia x 38.5" high	45 lbs



WITT

What Sets Us Apart



Discover unparalleled design freedom with Witt Custom waste receptacles – where aesthetics meet functionality.

Tailor your space with a partnership approach, offering options in size, color, material, and finish, including the incorporation of logos in design motifs.

Ensure user-friendly functionality, easy maintenance, and hygiene considerations.

Trust Witt for on-time delivery, top-notch customer service, and unwavering post-installation support – because your design deserves reliability.